

AXIS M3128-LVE Dome Camera

AI-powered 8 MP turret style camera

This AI-powered camera offers flexible installation both indoors and outdoors. With a turret-style design, it suppresses light reflections and delivers great 8 MP image quality and usability. And OptimizedIR allows for surveillance in complete darkness. It comes preinstalled with AXIS Object Analytics to detect, classify, track and count objects like humans and vehicles. Furthermore, Axis Edge Vault, a hardware-based cybersecurity platform, safeguards the device and offers FIPS 140-3 Level 3 certified secure key storage and operations. This weatherproof camera is IP66-rated and has an operating temperature range from -30 °C to 50 °C (-22 °F to 122 °F).

- > **Great image quality in 4K**
- > **WDR and OptimizedIR**
- > **Available in black or white**
- > **AI-based video analytics**
- > **Built-in cybersecurity with Axis Edge Vault**



AXIS M3128-LVE Dome Camera

Variants	Black White	One-click cloud connection ONVIF® Profile G, ONVIF® Profile M, ONVIF® Profile S, and ONVIF® Profile T, specifications at onvif.org
Camera		
Image sensor	1/2.8" progressive scan RGB CMOS Pixel size 1.45 µm	Video management systems Compatible with AXIS Companion, AXIS Camera Station, video management software from Axis' Application Development Partners available at axis.com/vms
Lens	2.9 mm, F2.0 Horizontal field of view: 110° Vertical field of view: 60° Minimum focus distance: 0.5 m (1.6 ft) M12 mount, fixed iris, IR corrected	Onscreen controls Day/night shift Wide dynamic range IR illumination Privacy masks Media clip Heater
Day and night	Automatic IR-cut filter	Edge-to-edge Speaker pairing
Minimum illumination	Color: 0.22 lux at 50 IRE, F1.2 B/W: 0.05 lux at 50 IRE, F1.2 0 lux with IR illumination on	Event conditions Device status: above/below/within operating temperature, IP address blocked, IP address removed, live stream active, network lost, new IP address, system ready Edge storage: recording ongoing, storage disruption, storage health issues detected I/O: manual trigger, virtual input is active MQTT: stateless Scheduled and recurring: schedule Video: average bitrate degradation, day-night mode, tampering
Shutter speed	1/71500 s to 2 s	Event actions Day-night mode: use day-night mode while the rule is active Illumination: use lights, use lights while the rule is active LEDs: flash status LED, flash status LED while the rule is active MQTT: send MQTT publish message Notification: HTTP, HTTPS, TCP and email Overlay text: use, use while the rule is active Recordings: record video, record video while the rule is active Security: erase configuration SNMP traps: send, send while the rule is active Upload of images or video clips: FTP, SFTP, HTTP, HTTPS, network share and email WDR mode: set, set while the rule is active
Camera angle adjustment	Pan ±180°, tilt 0 to 60°, rotation ±95°	Built-in installation aids Pixel counter, level grid
System on chip (SoC)		
Model	CV25	Analytics
Memory	2048 MB RAM, 512 MB Flash	Applications Included AXIS Object Analytics, AXIS Scene Metadata, AXIS Image Health Analytics, AXIS Live Privacy Shield ^c , AXIS Video Motion Detection, active tampering alarm Supported Support for AXIS Camera Application Platform enabling installation of third-party applications, see axis.com/acap
Compute capabilities	Deep learning processing unit (DLPU)	AXIS Object Analytics Object classes: humans, vehicles (types: cars, buses, trucks, bikes, other) Scenarios: line crossing, object in area, time in area, crossline counting, occupancy in area, motion in area, motion line crossing Up to 10 scenarios Other features: triggered objects visualized with color-coded bounding boxes Polygon include/exclude areas Perspective configuration ONVIF Motion Alarm event
Video		
Video compression	H.264 (MPEG-4 Part 10/AVC) Main and High Profiles H.265 (MPEG-H Part 2/HEVC) Main Profile Motion JPEG	AXIS Image Health Analytics Detection settings: Tampering: blocked image, redirected image Image degradation: blurred image, underexposed image Other features: sensitivity, validation period
Resolution	3840x2160 to 160x90	AXIS Scene Metadata Object classes: humans, faces, vehicles (types: cars, buses, trucks, bikes), license plates Object attributes: vehicle color, upper/lower clothing color, confidence, position
Frame rate	Up to 12/15 fps (12/15 Hz) with H.264 and H.265 ^a in all resolutions	Approvals
Video streaming	Multiple, individually configurable streams in H.264, H.265 and Motion JPEG Axis Zipstream technology in H.264 and H.265 Controllable frame rate and bandwidth VBR/ABR/MBR H.264/H.265	Product markings CSA, UL/cUL, BIS, CE, KC, EAC, VCCI, RCM, BSMI
Signal-to-noise ratio	>55 dB	Supply chain TAA compliant
WDR	Up to 120 dB depending on scene	EMC EN 55024, EN 55035, EN 55032 Class A, EN 61000-6-1, EN 61000-6-2 Australia/New Zealand: RCM AS/NZS CISPR 32 Class A Canada: ICES(A)/NMB(A) Japan: VCCI Class A Korea: KC KN35, KC KN32 Class A, KS C 9835, KS C 9832 Class A USA: FCC Part 15 Subpart B Class A
Multi-view streaming	2 individually cropped out view areas	
Image settings	Saturation, contrast, brightness, sharpness, white balance, day/night threshold, local contrast, exposure mode, exposure zones, compression, mirroring, text and image overlay, dynamic text and image overlay, privacy masks, polygon privacy mask	
Image processing	WDR, OptimizedIR	
Pan/Tilt/Zoom	Digital PTZ	
Audio		
Audio features	Voice enhancer through portcast technology Speaker pairing	
Audio streaming	Two-way (full duplex)	
Audio input	Input through portcast technology	
Audio output	Output through speaker pairing or portcast technology	
Audio encoding	AAC-LC 8/16/32/48 kHz, G.711 PCM 8 kHz, G.726 ADPCM 8 kHz, Opus 8/16/48 kHz, LPCM 48 kHz Configurable bitrate	
Network		
Network protocols	IPv4, IPv6 USGv6, ICMPv4/ICMPv6, HTTP, HTTPS ^b , HTTP/2, TLS ^b , QoS Layer 3 DiffServ, FTP, SFTP, CIFS/SMB, SMTP, mDNS (Bonjour), UPnP [®] , SNMP v1/v2c/v3 (MIB-II), DNS/DNSv6, DDNS, NTP, NTS, RTSP, RTP, SRTP/RTSPS, TCP, UDP, IGMPv1/v2/v3, RTPC, ICMP, DHCPv4/v6, ARP, SSH, LLDP, CDP, MQTT v3.1.1, Secure syslog (RFC 3164/5424, UDP/TCP/TLS), Link-Local address (ZeroConf)	
System integration		
Application Programming Interface	Open API for software integration, including VAPIX [®] , metadata and AXIS Camera Application Platform (ACAP); specifications at axis.com/developer-community . ACAP includes Native SDK.	

Safety	IEC/EN/UL 62368-1 ed. 3, IEC/EN 62471 risk group exempt, UL 60950-22, IS 13252
Environment	IEC 60068-2-1, IEC 60068-2-2, IEC 60068-2-6, IEC 60068-2-14, IEC 60068-2-27, IEC 60068-2-78, IEC/EN 60529 IP66, IEC/EN 62262 IK08, NEMA 250 Type 4X
Network	NIST SP500-267
Cybersecurity	ETSI EN 303 645
Cybersecurity	
Edge security	<p>Software: Signed firmware, brute force delay protection, digest authentication and OAuth 2.0 RFC6749 OpenID Authorization Code Flow for centralized ADFS account management, password protection</p> <p>Hardware: Axis Edge Vault cybersecurity platform</p> <p>Secure element (CC EAL 6+, FIPS 140-3 Level 3), system-on-chip security (TEE), Axis device ID, secure keystore, signed video, secure boot, encrypted filesystem (AES-XTS-Plain64 256bit)</p>
Network security	IEEE 802.1X (EAP-TLS, PEAP-MSCHAPv2) ^P , IEEE 802.1AE (MACsec PSK/EAP-TLS),
Documentation	<p><i>AXIS OS Hardening Guide</i></p> <p><i>Axis Vulnerability Management Policy</i></p> <p><i>Axis Security Development Model</i></p> <p>AXIS OS Software Bill of Material (SBOM)</p> <p>To download documents, go to axis.com/support/cybersecurity/resources</p> <p>To read more about Axis cybersecurity support, go to axis.com/cybersecurity</p>
General	
Casing	<p>IP66-, NEMA 4X- and IK08-rated</p> <p>Polycarbonate hard-coated window</p> <p>Plastic casing</p> <p>Color: white NCS S 1002-B, black NCS S 9000-N</p> <p>For repainting instructions, go to the product's support page. For information about the impact on warranty, go to axis.com/warranty-implication-when-repainting.</p>
Power	<p>Power over Ethernet (PoE) IEEE 802.3af/802.3at Type 1 Class 3</p> <p>Typical 4.3 W, max 10.5 W</p> <p>Features: power meter</p>
Connectors	Network: RJ45 10BASE-T/100BASE-TX PoE
IR illumination	<p>OptimizedIR with power-efficient, long-life 850 nm IR LEDs</p> <p>Range of reach 20 m (65 ft) or more depending on the scene</p>
Storage	<p>Support for microSD/microSDHC/microSDXC card</p> <p>Support for SD card encryption (AES-XTS-Plain64 256bit)</p> <p>Recording to network-attached storage (NAS)</p> <p>For SD card and NAS recommendations see axis.com</p>
Operating conditions	<p>Maximum temperature according to NEMA TS 2 (2.2.7): 74 °C (165 °F)</p>

	Humidity: 10–100% RH (non-condensing)
Storage conditions	<p>Temperature: -40 °C to 65 °C (-40 °F to 149 °F)</p> <p>Humidity: 5–95% RH (non-condensing)</p>
Dimensions	<p>For the overall product dimensions, see the dimension drawing in this datasheet.</p> <p>Effective Projected Area (EPA): 0.008 m² (0.03 ft²)</p>
Weight	390 g (0.9 lb)
Box content	Camera, installation guide, connector guard, cable gaskets, owner authentication key
Optional accessories	<p>AXIS TM3212 Recessed Mount, AXIS TM3213 Recessed Mount, AXIS TM3824-E Weathershield, AXIS T94B01P Conduit Back Box, AXIS T94B02D Pendant Kit</p> <p>AXIS T8415 Wireless Installation Tool</p> <p>AXIS Surveillance Cards</p> <p>For more accessories, go to axis.com/products/axis-m3128-lve#accessories</p>
System tools	<p>AXIS Site Designer, AXIS Device Manager, product selector, accessory selector, lens calculator</p> <p>Available at axis.com</p>
Languages	English, German, French, Spanish, Italian, Russian, Simplified Chinese, Japanese, Korean, Portuguese, Polish, Traditional Chinese, Dutch, Czech, Swedish, Finnish, Turkish, Thai, Vietnamese
Warranty	5-year warranty, see axis.com/warranty
Part numbers	Available at axis.com/products/axis-m3128-lve#part-numbers
Sustainability	
Substance control	<p>PVC free</p> <p>RoHS in accordance with EU RoHS Directive 2011/65/EU/ and 2015/863, and standard EN IEC 63000:2018</p> <p>REACH in accordance with (EC) No 1907/2006. For SCIP UUID, see echa.europa.eu</p>
Materials	<p>Renewable carbon-based plastic content: 49% (recycled: 6%, bio-based: 43%)</p> <p>Screened for conflict minerals in accordance with OECD guidelines</p> <p>To read more about sustainability at Axis, go to axis.com/about-axis/sustainability</p>
Environmental responsibility	<p>axis.com/environmental-responsibility</p> <p>Axis Communications is a signatory of the UN Global Compact, read more at unglobalcompact.org</p>

- a. *Reduced frame rate in Motion JPEG*
- b. *This product includes software developed by the OpenSSL Project for use in the OpenSSL Toolkit. (openssl.org), and cryptographic software written by Eric Young (eyay@cryptsoft.com).*
- c. *Available for download*

Detect, Observe, Recognize, Identify (DORI)

	DORI definition	Distance
Detect	25 px/m (8 px/ft)	80 m (262 ft)
Observe	63 px/m (19 px/ft)	31.7 m (104.0 ft)
Recognize	125 px/m (38 px/ft)	16 m (52 ft)
Identify	250 px/m (76 px/ft)	8 m (26 ft)

The DORI values are calculated using pixel densities for different use cases as recommended by the EN-62676-4 standard. The calculations use the center of the image as the reference point and consider lens distortion. The possibility to recognize or identify a person or object depends on factors such as object motion, video compression, lighting conditions, and camera focus. Use margins when planning. The pixel density varies across the image, and the calculated values can differ from the distances in the real world.

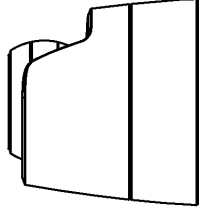
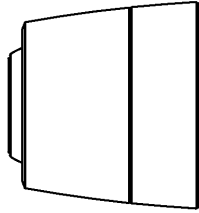
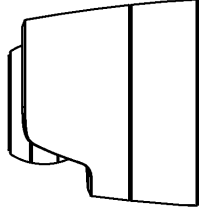
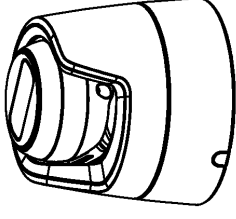
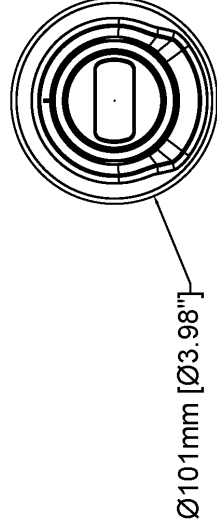
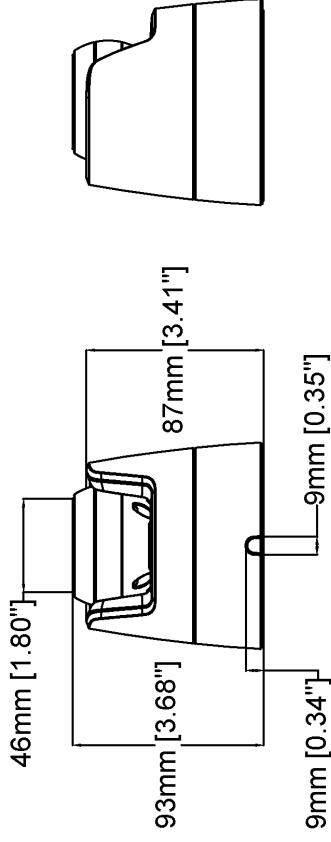
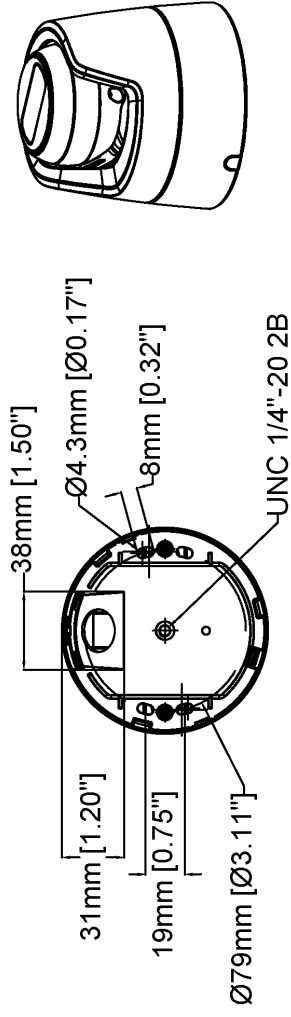

AXIS M3128-LVE Dome Camera

Revision	v.01	Revision date	2024-06-04
Paper size	A4	Release date	2024-06-04
Created by	MS	Scale	1:3

Highlighted capabilities

AXIS Object Analytics

AXIS Object Analytics is a preinstalled, multifeatured video analytics that detects and classifies humans, vehicles, and types of vehicles. Thanks to AI-based algorithms and behavioral conditions, it analyzes the scene and their spatial behavior within – all tailored to your specific needs. Scalable and edge-based, it requires minimum effort to set up and supports various scenarios running simultaneously.

Axis Edge Vault

Axis Edge Vault is the hardware-based cybersecurity platform that safeguards the Axis device. It forms the foundation that all secure operations depend on and offer features to protect the device's identity, safeguard its integrity and protect sensitive information from unauthorized access. For instance, **secure boot** ensures that a device can boot only with **signed OS**, which prevents physical supply chain tampering. With signed OS, the device is also able to validate new device software before accepting to install it. And the **secure keystore** is the critical building-block for protecting cryptographic information used for secure communication (IEEE 802.1X, HTTPS, Axis device ID, access control keys etc.) against malicious extraction in the event of a security breach. The secure keystore and secure connections are

provided through a Common Criteria or FIPS 140 certified hardware-based cryptographic computing module.

To read more about Axis Edge Vault, go to axis.com/solutions/edge-vault.

OptimizedIR

Axis OptimizedIR provides a unique and powerful combination of camera intelligence and sophisticated LED technology, resulting in our most advanced camera-integrated IR solutions for complete darkness. In our pan-tilt-zoom (PTZ) cameras with OptimizedIR, the IR beam automatically adapts and becomes wider or narrower as the camera zooms in and out to make sure that the entire field of view is always evenly illuminated.

Zipstream

The Axis Zipstream technology preserves all the important forensic in the video stream while lowering bandwidth and storage requirements by an average of 50%. Zipstream also includes three intelligent algorithms, which ensure that relevant forensic information is identified, recorded, and sent in full resolution and frame rate.