

## **AXIS Companion Recorder 8CH**

## **User Manual**

# AXIS Companion Recorder 8CH

## About AXIS Companion Recorder 8CH

---

### About AXIS Companion Recorder 8CH

AXIS Companion Recorder is a compact network video recorder for up to 8 Axis network cameras. It includes a built in PoE switch for easy installation. The device features a surveillance-grade hard disk and a fan-less design. It also includes a USB port for easy export of video footage. A wireless access point is included for installation and direct access to the system with mobile devices. AXIS Companion Recorder comes in two models – including a 2 TB or a 4 TB hard disk.

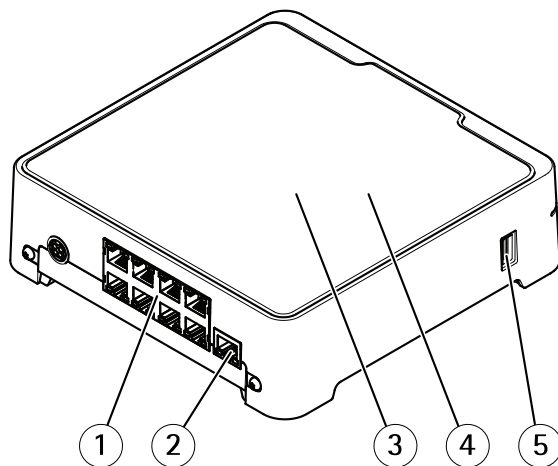

- 1 PoE port (8x)
- 2 LAN port
- 3 Hard disk
- 4 Wireless access point
- 5 USB port

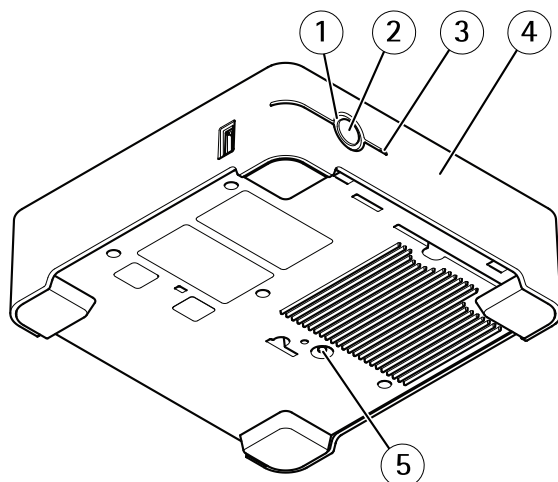

- 1 Status LED
- 2 Control button
- 3 Hard disk LED
- 4 Alarm buzzer
- 5 Reset button

# AXIS Companion Recorder 8CH

## About AXIS Companion Recorder 8CH

---

### How many cameras can I connect to the recorder?

While it is possible to physically connect a lot of cameras to the recorder, the system is limited by these factors:

- The recorder has a limit of 8 network shares, so there can be a maximum of 8 cameras recording to the hard disk.
- The recorder has 8 PoE ports, so it can supply up to 8 cameras with power. For more information about power limitations, see *How much power can the recorder supply to the cameras?* on page 3.

### How much power can the recorder supply to the cameras?

These are the limitations for power over Ethernet (PoE):

- The recorder can supply up to eight cameras with PoE.
- The total amount of power available is 65 W.
- Each network port supports up to 12.95 W (IEEE 802.1af/802.1at Type 1 Class 3).

# AXIS Companion Recorder 8CH

## The AXIS Companion solution

---

### The AXIS Companion solution

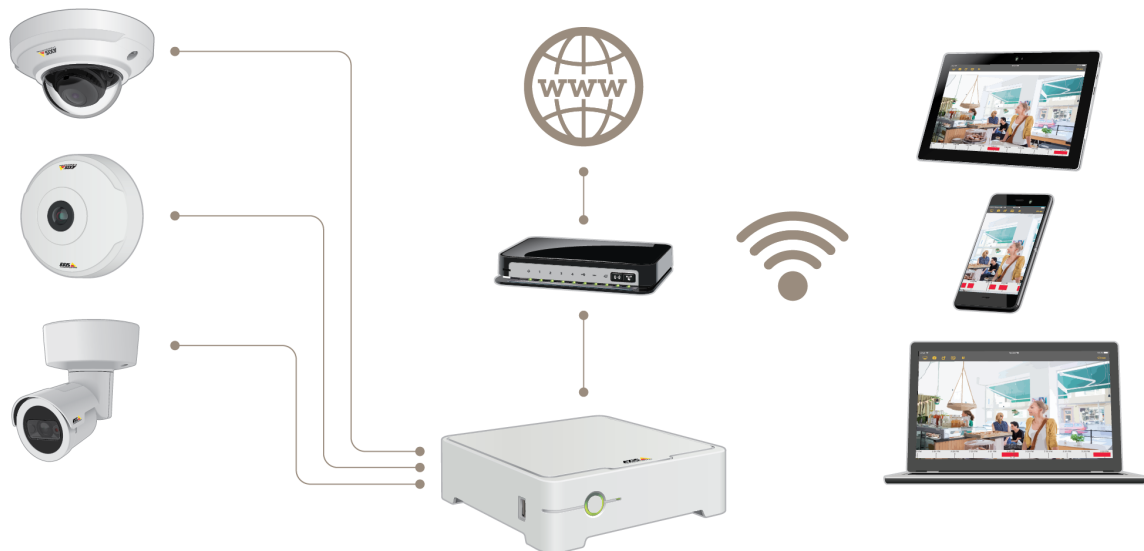

AXIS Companion is a complete end-to-end surveillance solution designed to meet the requirements of small systems with basic surveillance requirements.

An AXIS Companion solution can consist of:

- AXIS Companion cameras, Axis IP cameras and encoders with firmware 8.40 or higher.
- AXIS Companion recorders.
- Axis system accessories, such as memory cards and switches.
- AXIS Companion software for Windows computers as well as mobile devices and TV streaming devices (iOS and Android).

### Learn more about AXIS Companion

For video tutorials and web apps, visit [axis.com/products/axis-companion/how-it-works](http://axis.com/products/axis-companion/how-it-works)

# AXIS Companion Recorder 8CH

## Get started

---

### Get started

#### Note

Internet access is required during the system setup.

#### Installation overview:

1. *Register a MyAxis account on page 5*
2. *Install the hardware on page 5*
3. *Install the desktop app on page 6*
4. *Create a site on page 6*
5. *Install the mobile app on page 7*

#### Result of system installation:

- The firmware is upgraded on all Axis devices.
- A password is set for the devices.
- The recordings are enabled with default settings.
- The remote access is enabled.

### Register a MyAxis account

Register a MyAxis account at [axis.com/my-axis/login](https://axis.com/my-axis/login)

### Install the hardware

1. Install your camera hardware.
2. Connect the recorder to your network.

#### Note

If you have no recorder, then you need a camera with an SD card if you want to be able to record video.

3. Connect the cameras to the recorders integrated PoE switch or an external PoE switch.
4. Connect the computer to the same network as the recorder.

# AXIS Companion Recorder 8CH

## Get started

---

5. Connect the power cable to your recorder, and wait a few minutes for the recorder and cameras to boot up before proceeding.

### ⚠CAUTION

Keep the recorder in a well ventilated environment and with plenty of empty space around the recorder to avoid overheating.

## Install the desktop app

1. Go to [axiscompanion.com/vms](https://axiscompanion.com/vms) and click **Download** to download the AXIS Companion desktop app for Windows.
2. Sign in using your *MyAxis* account.
3. Read the license agreement, and select one of the alternatives to proceed.
4. Save the file to a location of your choice.
5. Open the file, and click **Run** to start the installation.
6. If you want to allow the app to make changes on your device, click **Yes**.
7. Select language and click **OK**.
8. Follow the setup wizard.

## Create a site

A site is a single point of entry to a surveillance solution, for example all cameras in a store. You can keep track of several sites through a single MyAxis account.

### Note

If you have used an earlier version of AXIS Companion, then you might have devices that are not supported in AXIS Companion version 4. Unsupported devices include third-party NAS devices and old Axis devices with a firmware that can't be updated to 8.40 or later. The wizard will inform you about any such issues and help you to address them.

### Note

Sites that were created in an earlier version than AXIS Companion version 4, will not appear in the list of sites. You can read the Migration Guide (available on the support web page) for more information.

1. Start the AXIS Companion desktop app.
2. Sign in with your *MyAxis* account.
3. Click **Get started**.
4. Name your site and enter your company name.
5. Click **Next**.
6. Select the devices you want to add to your site.

If any devices are password-protected, then you must enter the password for them before they can be selected.

# AXIS Companion Recorder 8CH

## Get started

---

### Note

If you have devices that are not supported, then you can click **Read more** to find out why they are not supported.

7. Click **Next**.

8. Enter a password.

This password is used for accessing the device webpages or offline mode in the AXIS Companion mobile app.

9. Click **Next**.

10. On the **Ready to install** page, there might be a list of cameras that need to be restored. If so, click the **Restore device** link to fix the issue on the device webpage.

11. Click **Finish** and wait while AXIS Companion configures the cameras.

### Note

The configuration may take several minutes.

For getting-started video tutorials, see *AXIS Companion tutorials*.

## Install the mobile app

1. Go to your App store or Google play.
2. Search for **AXIS Companion 4** and download the app.
3. Sign in to AXIS Companion with your *MyAxis account*.

To find out more on how to use the app, see *AXIS Companion tutorials*.

# AXIS Companion Recorder 8CH

## Daily use

---

### Daily use

#### How to connect to the recorder's wireless network

1. In the AXIS Companion client, go to  and log in to the product's webpage.
2. Select Wireless > Access point and enable WLAN.
3. At the bottom of the recorder, locate the label with the network name (SSID) and the password.
4. Use the network name and password to connect to the wireless network.

#### Access your cameras

1. Sign in to AXIS Companion on a computer or a mobile device using your *MyAxis account*.
2. Enter the site that contains your cameras.

Find out more at *AXIS Companion tutorials*.

#### View live video

1. Go to 
2. Select which camera you want to view.

To watch a video of how to zoom, pan and take snapshots, see the *AXIS Companion tutorials*.

#### Play a recording

1. Go to 
2. Use the timeline and calendar to find the recording.
3. Select the camera in the timeline and move the playback marker to the desired time.
4. Click **Play**.

To watch a video of how to browse and play recordings, see the *AXIS Companion tutorials*.





# AXIS Companion Recorder 8CH

## Daily use

---

### Save a recording

1. Go to  > .
2. Select start and end times for a camera recording.
3. Select which cameras to save recordings from.
4. Save the recording.

To watch a video of how to save recordings, see the *AXIS Companion tutorials*.

### Play a saved recording

To play a saved recording, open it with AXIS File Player.

When you save a recording, the AXIS File Player will be saved in the same folder. The AXIS File Player has a timeline showing what time the recording was made.

### Validate a saved recording

You can validate a recording to confirm that the timestamp and images have not been manipulated after the recording was first saved. For this purpose, a digital signature will be included in the file when you save a recording. You can add a password to the digital signature for increased security.

Protect your digital signature with a password:

1. In AXIS Companion, go to  > **Customize**.
2. Under **Recordings**, select **Show digital signature options when saving recordings**.

When saving a recording now, the **Digital signature** window will appear, allowing you to choose a password for the signature.

Validate a recording:

1. Open the saved recording with AXIS File Player.
2. Click **Tools** and select **Verify digital signature**.
3. Enter password, if a password was applied to the signature, and click **OK**.

A window appears to inform whether or not the recording is valid.

### Take a snapshot

Take a snapshot from live view:



- Click 

# AXIS Companion Recorder 8CH

## Daily use

---



Take a snapshot from recordings:

1. Use the timeline and calendar to find the recording.
2. Select the camera in the timeline and move the playback marker to the desired time.
3. Click  to start investigation mode.
  - Investigation mode allows you to step through the recorded video, frame by frame, to find the exact moment when an incident happened and take a snapshot from that moment.
4. To find the incident, click on the thumbnails to step 30, 15, 5 or 1 frames backward (top panel) or forward (bottom panel). You can also move the slider.
5. When satisfied, click  to take a snapshot.
  - For most cameras the snapshot will contain the entire camera image, regardless of the zoom level. For cameras with a dewarped image, the snapshot will be the zoomed-in image.

Change the folder where snapshots are saved:

1. Go to  > Customize.
2. Change the settings under **Snapshots**.

## Adjust the image settings

1. Go to  > Cameras.
2. Click  >  for the camera you want to adjust.

You can control the image by adjusting settings like:

- Appearance
- White balance
- Exposure
- Overlay
- Day & Night
- Privacy mask

## Configure the video quality

You can configure the video quality to suit your image quality requirements and bandwidth usage. Video quality settings affect motion recording, continuous recording and live view.

1. Go to  > Cameras.

# AXIS Companion Recorder 8CH

## Daily use



---

2. Right-click the camera you want to configure and select **Video Quality Settings**.
3. Edit the profile settings for:
  - **High** (resolutions with an image width above 640 pixels)
  - **Low** (resolutions with an image width up to 640 pixels)
  - **Axis Mobile Streaming**
4. Select **Axis Mobile Streaming** to improve playback performance for thumbnails and mobile apps.
  - **Axis Mobile Streaming** is activated when there is only one **High** profile active and the resolution is set for HD (1280x720) or above. Selecting **Axis Mobile Streaming** slightly increases storage usage.
  - When playing recordings, only those recorded with **Axis Mobile Streaming** enabled can toggle between **High** and **Low**.
5. Click **OK** to save.

## Configure video motion detection

Recording only when motion is detected saves considerably on disk space and bandwidth, compared to continuous recording.

If the motion detection is triggered too often, you can adjust the settings to ignore parts of the view or certain types of events.

1. In AXIS Companion, go to  > **Cameras**.
2. Make sure the camera is enabled in the **Motion detection** column.
3. Click  for a camera and select **Motion recording....**
4. In the **Motion recording** dialog, click **Settings....**
5. Choose what part of the camera view to include in the motion detection:
  - Edit the dark area to be included for motion detection.
  - To draw an area that will be excluded from motion detection, select **Exclude area** and edit the light area.

### Note

For some camera models you can only draw squares, and for others you can draw more complex polygons.

6. Expand **Advanced** to adjust the settings of the filters.
  - **Small objects filter** – Ignore objects that are small, such as animals.
  - **Swaying objects filter** – Ignore objects that only move within a short distance, such as trees or flags that move when it is windy.

### Note

The swaying objects filter is not available for all camera models.

- **Short-lived objects filter** – Ignore objects that only appear for a short period of time, such as light beams from passing cars or fast-moving shadows.
7. Click **OK** twice.

# AXIS Companion Recorder 8CH

## Daily use

---

### Set up notifications

Notifications are triggered by motion detection and sent to the mobile app.

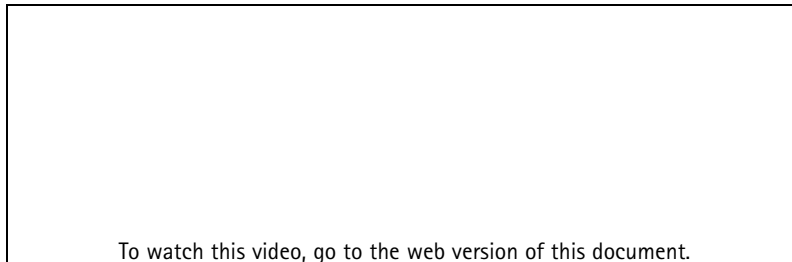

To watch this video, go to the web version of this document.

[www.axis.com/products/online-manual/22543](http://www.axis.com/products/online-manual/22543)

1. Go to  > Notifications.
2. Under **Schedule**, set the time interval when you want notifications to be sent.
3. Under **Activation**, select the cameras you want notifications from.

Receiving notifications on your mobile device:

- Push notifications are sent to your mobile app if you are logged in to your MyAxis account on your mobile.
- When you install the AXIS Companion 4 mobile app, you must accept when prompted with a question if you want to receive notifications. If you want to deactivate the notifications later on, go to the settings of your mobile device, select the AXIS Companion 4 app, and disable the notifications.
- When a notification is sent, it will appear as a popup message on your mobile device. Tap the message to open the playback of the ongoing event.

### Add a user



1. Go to  > Users.
2. Click **Add...**
3. Enter an email address and select an access level, then click **OK**.

# AXIS Companion Recorder 8CH

## Daily use

---

The following access levels are available:

Administrator	 Full access
Operator	 Can access recordings and live view, but can't make any changes to the site
Viewer	 Can only access live view

### Activate offline mode

If you are running AXIS Companion while there is no connection to the internet, then you can enter offline mode. This makes Live view and Recordings available locally. However, you will not be able to access the Configuration menu while the internet connection is down.

Activate offline mode:

- Click  > Site and turn on Offline mode.

### Show video on an external display

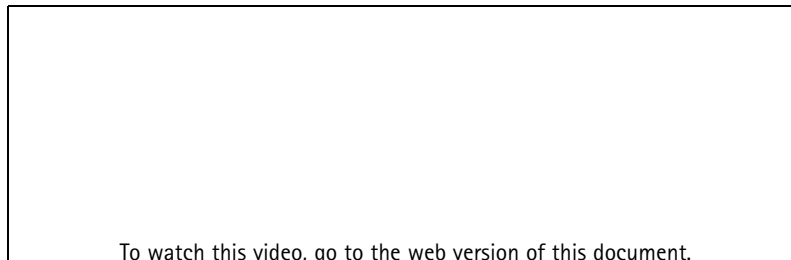

[www.axis.com/products/online-manual/22543](http://www.axis.com/products/online-manual/22543)

What you need:



- An Apple TV or Android TV device.
- The AXIS Companion 4 app installed on your mobile device.
- The AXIS Companion TV app installed from the app store on your Apple TV or Android TV device.

# AXIS Companion Recorder 8CH

## Daily use

---

This is how you do it:

1. Go to  > **Network** to connect your mobile device to the same network as your external display.
2. Open the AXIS Companion 4 mobile app and log in.
3. Go to **Devices** >  and select your external display.

### Note



It may take a few seconds before the icon appears.

4. Select the cameras you want to show on your external display.
5. Tap  and wait for the configuration to complete.
6. You can view a single camera at a time or create a split view with up to 16 cameras.
7. When the AXIS Companion 4 TV app opens, read the instructions on the screen about how to navigate in the app.

## Monitor a narrow space

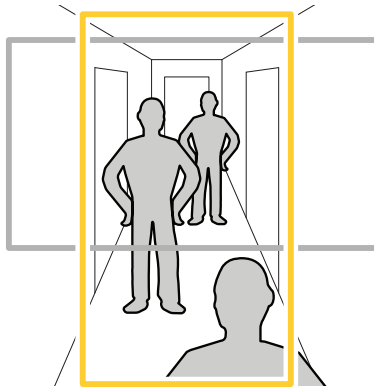
Use corridor format to better utilize the full field of view in a long and narrow space, for example a staircase, hallway, road, or tunnel.



1. Adjust the camera or its lens to a vertical field of view.
2. In AXIS Companion, go to  > **Cameras**.
3. On the row of the camera you want to adjust, click  > **Image settings**.
4. On the **Appearance** tab, select a suitable angle for **Orientation**.
5. Click **Close**.

# AXIS Companion Recorder 8CH

## Daily use

---

### Connect to a door station

You can connect a door station to both your AXIS Companion desktop app as well as the mobile app. This makes it possible for you to answer calls, unlock a door and view a door station video with your mobile device.

#### Note

To unlock a door, your door station must be properly connected to the door's electronic lock. The documentation for your door station contains information about how to make this connection correctly. To find the documentation for your door station, go to [axis.com/products/access-control/network-door-stations](https://axis.com/products/access-control/network-door-stations)

#### Note

Make sure the door station is connected to the same network as your computer, otherwise it won't show up in the list of devices in your AXIS Companion apps.

### Connect your desktop app to a door station

1. In the AXIS Companion desktop app, go to  > **Cameras**.
2. Click **Add devices** and add the door station.

You can now answer the door station with your AXIS Companion desktop app.

### Connect your mobile app to a door station

1. *Connect your desktop app to a door station on page 15.*
2. Start the AXIS Companion 4 mobile app.
3. Log in to the same MyAxis account as you used for the desktop app.

You can now answer the door station with your AXIS Companion 4 mobile app.

Give other users access to the door station:

1. From the AXIS Companion desktop app, go to  > **Users**.
2. Invite the user to the site.

Turn off calls from the door station:

1. In the AXIS Companion 4 mobile app, go to **User**.
2. Go to **Notifications** and turn off **Door station calls**.

### Add cameras to your site

1. Connect the cameras to the recorders integrated PoE switch or an external PoE switch.

2. Go to  > **Cameras**.
3. Click **Add devices**.
4. Select the devices you want to add to your site.

If any devices are password-protected, then you must enter the password for them before they can be selected.

#### Note

If you have devices that are not supported, then you can click **Read more** to find out why they are not supported.

# AXIS Companion Recorder 8CH

## Daily use



---

5. Click **Next**.
6. Enter a password.  
This password is used for accessing the device webpages or offline mode in the AXIS Companion mobile app.
7. Click **Next**.
8. On the **Ready to install** page, there might be a list of cameras that need to be restored. If so, click the **Restore device** link to fix the issue on the device webpage.
9. Click **Finish** and wait while AXIS Companion configures the cameras.

### Note

The configuration may take several minutes.

## Remove a camera from your site

1. Go to  > **Cameras**.
2. On the row of the camera you want to remove, click  > **Remove**.
3. If the camera has ongoing recordings, select **Stop motion and continuous recording** to stop recordings.
4. Click **OK**.



# AXIS Companion Recorder 8CH

## Troubleshooting

---

### Troubleshooting

The status LED gives you the following information:

Status LED	Indication
Green	The recorder is on and the status is ok.
Orange	The recorder is starting up, or the firmware is upgrading. Wait until the LED turns green.
Red	This can mean:  a)The PoE budget is exceeded. If you just connected a device to the recorder, try removing it again. For more information about PoE limitations, see <i>How much power can the recorder supply to the cameras? on page 3</i> .  b)There is a hard disk error. This could mean that the temperature is too high or that there is an error on the disk.

The hard disk LED gives you the following information:

Status LED	Indication
Green	The hard disk is ok. The LED is flashing green when data is written to the disk.
Red	There is a hard disk error. This could mean that the temperature is too high or that there is an error on the disk.

The buzzer sounds for one of these reasons:

- The PoE budget is exceeded. If you just connected a device to the recorder, try removing it again. For more information about PoE limitations, see *How much power can the recorder supply to the cameras? on page 3*
- There is a hard disk error. This could mean that the temperature is too high or that there is an error on the disk.

#### Note

You can stop the buzzer with a short press of the control button.

The recorder shuts down:

- The recorder is severely overheated.

### SD card slot

For SD card recommendations, see [axiscompanion.com](http://axiscompanion.com).

### Buttons

#### Control button

The control button is used for:

- Resetting the product to factory default settings. See *Hard reset a camera on page 19* or *Hard reset a recorder on page 19*

# AXIS Companion Recorder 8CH

## Troubleshooting

---

### Technical issues, clues and solutions

Issue	Solution
I have no live view.	Go to <i>Fix common issues on page 18</i> .
My recordings are not available.	Go to <i>Fix common issues on page 18</i> .
I cannot connect to my cameras.	Go to <i>Fix common issues on page 18</i> .
I receive error notification: "No contact".	Go to <i>Fix common issues on page 18</i> .
My sites do not appear in my mobile app.	Make sure you have version 4 of the AXIS Companion mobile app.

### Fix common issues

Before you restart, configure or reset your devices, we recommend you to save a system report so that you don't lose any valuable data.

See *Save a system report on page 21*.

1. Check that your cameras and recorder have power.
2. Check that you are connected to the internet.  
See *Activate offline mode on page 13*.
3. Check that the network is working.
4. Check that the cameras are connected to the same network as the computer, unless you are remote.

Still not working?

5. Make sure that your cameras, recorder and AXIS Companion desktop app have the latest firmware and software updates.  
See *Upgrade firmware on page 18*.
6. Restart the AXIS Companion desktop app.
7. Restart your cameras and recorder.

Still not working?

8. Make a hard reset on the cameras and the recorder, to completely put them back to factory default settings.  
See *Hard reset a camera on page 19* and *Hard reset a recorder on page 19*.
9. Add the reset cameras to your site again.

Still not working?

10. Save a system report and contact *Axis technical support*.  
See *Save a system report on page 21*.

### Upgrade firmware

New firmware updates bring you to the latest and improved set of features, functions, and security enhancements.

# AXIS Companion Recorder 8CH

## Troubleshooting

---

1. Go to 
2. Click **Upgrade firmware**.
3. If new firmware is available, then select the devices you want to upgrade.
4. Click **OK**.

### Hard reset a camera

#### Note

A hard reset will not affect your recordings.

#### Note

A hard reset will reset all the settings, including the IP address.

1. Select the camera you want to hard reset and remove it from the site.  
*See [Remove a camera from your site on page 16](#).*
2. Disconnect the power from the device.
3. Press and hold the control button on the device, and then reconnect the power.  
Keep the control button pressed for 15–30 seconds until the status LED indicator flashes amber.
4. Release the control button.  
The process is complete when the status LED indicator turns green.  
The product has now been reset to the factory default settings.
5. Add the camera to the site again, see [Add cameras to your site on page 15](#).

### Hard reset a recorder

#### **⚠WARNING**

Move the recorder very gently while it is switched on. Sudden moves or shocks may damage the hard disk.

#### Note

A hard reset will not affect your recordings.

#### Note

A hard reset will reset all the settings, including the IP address.

1. Switch off the recorder:  
Press the power button on the front of the recorder for 4–5 seconds until you hear a beep.
2. Wait until the recorder is switched off, then turn it over to access the reset button.
3. Press and hold the reset button. Press and release the control button to start the recorder. Release the reset button after 15–30 seconds when the LED indicator flashes amber.
4. Slowly put the recorder back in its place.

# AXIS Companion Recorder 8CH

## Troubleshooting

---

5. The process is complete when the status LED indicator turns green. The product has been reset to the factory default settings. If no DHCP server is available on the network, the default IP address is 192.168.0.90
6. Reset your cameras connected to the recorder. See *Hard reset a camera on page 19*.

### What to do if you forget the site password

It is not possible to reset the site password, so if you forget the password you will no longer be able to log on to the site.

However, it is possible to create a new site and add the same cameras and storage to that. All old recordings will be available from the new site.

1. Reset all products to factory default settings, see *Hard reset a recorder on page 19*.
2. Create a new site, see *Create a site on page 6*.

### I can't log in to the product's webpage



If you set a password for the product during configuration, and later add that product to a site, you can no longer log in to the product's webpage with the password you've set. This is because AXIS Companion software changes the passwords of all devices in the site.

To log in to a device in your site, type the user name **ACCAdmin** and your site password.



### How to replace a camera

#### Note

The recorder reserves a share for each camera in the system. If you remove a camera from the system, you need to remove its share from the recorder before you add another camera.

1. Go to  and select a product in the list.
2. Select **Storage** .
3. Select **Webpage** and log on to the recorder's webpage.
4. Go to **Network shares**.
5. Select and delete the share.
6. Close the recorder's webpage and add the new camera in AXIS Companion, see *Add cameras to your site on page 15*.

### How to erase all recordings

1. Go to  and select a product in the list.
2. Under **Storage**, select .
3. Select **Webpage** and log on to the recorder's webpage.
4. Go to **Disks > Disk action** and select **Reset disk**.

# AXIS Companion Recorder 8CH

## Troubleshooting

---

### Note

This procedure erases all recordings from the hard disk, but the configuration of the recorder and the site doesn't change.

### Save a system report

1. Click  > Save system report.
2. When you register a new case at Axis Helpdesk, attach the system report.

