

# AXIS Q1728 Block Camera

8 MP, superior light sensitivity, enclosure-ready

Built on an Axis system-on-chip, this AI-powered camera delivers 4K resolution and includes a large 1/1.2" sensor to ensure consistent performance even in low-light. A deep learning processing unit lets you run advanced features and powerful analytics on the edge. Preinstalled with AXIS Object Analytics, this camera detects and counts objects. It also features AXIS Image Health Analytics for optimal performance, and AXIS Live Privacy Shield for AI-based dynamic masking. Axis Zipstream with support for AV1, H.264/H.265 significantly lowers bandwidth and storage requirements. It's available with a wide or tele lens and fits into most enclosures including Axis and third-party enclosures.

- > [Superior image quality in 4K](#)
- > [Designed to fit into most enclosures](#)
- > [Next-generation AI-powered analytics](#)
- > [Wide or tele lenses available](#)
- > [Built-in cybersecurity with Axis Edge Vault](#)



# AXIS Q1728 Block Camera

<b>Camera</b>		
<b>Variants</b>	AXIS Q1728 13 mm AXIS Q1728 48 mm	
<b>Image sensor</b>	1/1.2" progressive scan RGB CMOS Pixel size 2.9 µm	
<b>Lens</b>	IR corrected, P-iris control 13 mm lens: Varifocal, 5.9–13.3 mm, F1.6–2.9 Horizontal field of view: 108°–49° Vertical field of view: 58°–27° Minimum focus distance: 0.5 m (1.6 ft) 48 mm lens: Varifocal, 15.2–48.7 mm, F1.7 Horizontal field of view: 42°–13° Vertical field of view: 24°–7° Minimum focus distance: 1.5 m (4.9 ft)	
<b>Day and night</b>	Automatic IR-cut filter Hybrid IR filter	
<b>Minimum illumination</b>	13 mm lens: With WDR and Lightfinder Color: 0.05 lux at 50 IRE, F1.6–2.9 B/W: 0.01 lux at 50 IRE, F1.6–2.9 48 mm lens: With WDR and Lightfinder Color: 0.05 lux at 50 IRE, F1.7 B/W: 0.01 lux at 50 IRE, F1.7	
<b>Shutter speed</b>	1/66500 s to 2 s	
<b>System on chip (SoC)</b>		
<b>Model</b>	ARTPEC-9	
<b>Memory</b>	4 GB RAM, 8 GB Flash	
<b>Compute capabilities</b>	Deep learning processing unit (DLPU)	
<b>Video</b>		
<b>Video compression</b>	H.264 (MPEG-4 Part 10/AVC) Baseline, Main and High Profiles H.265 (MPEG-H Part 2/HEVC) Main Profile Motion JPEG AV1	
<b>Resolution</b>	16:9:3840x2160 to 160x90 16:10: 2560x1600 to 160x100 4:3: 2592x1944 to 160x120	
<b>Frame rate</b>	With WDR: Up to 25/30 fps (50/60 Hz) in all resolutions No WDR: Up to 50/60 fps (50/60 Hz) in all resolutions	
<b>Video streaming</b>	Up to 20 unique and configurable video streams <sup>a</sup> Axis Zipstream technology in H.264, H.265 and AV1 Controllable frame rate and bandwidth VBR/ABR/MBR H.264/H.265/AV1 Low latency mode Video streaming indicator	
<b>Signal-to-noise ratio</b>	>55 dB	
<b>WDR</b>	Forensic WDR: Up to 120 dB depending on scene	
<b>Multi-view streaming</b>	Up to 7 individually cropped out view areas	
<b>Noise reduction</b>	Spatial filter (2D noise reduction) Temporal filter (3D noise reduction)	
<b>Image settings</b>	Saturation, contrast, brightness, sharpness, white balance, day/night threshold, local contrast, tone mapping, exposure mode, exposure zones, defog, barrel distortion correction, electronic image stabilization, compression, rotation: auto, 0°, 90°, 180°, 270° including corridor format, mirroring, dynamic text and image overlay, overlay widget, polygon and mosaic privacy mask, target aperture Scene profiles: forensic, vivid, traffic overview	
<b>Image processing</b>	Forensic WDR, Lightfinder 2.0	
<b>Pan/Tilt/Zoom</b>	Digital PTZ, preset positions, preset position tour Uploadable PTZ driver (Pelco D, Visca and APTP pre-installed)	
<b>Audio</b>		
<b>Audio features</b>	Automatic gain control	10-band graphic equalizer for audio input Speaker pairing, microphone pairing
<b>Audio streaming</b>	Configurable duplex: One-way (simplex, half duplex) Two-way (half duplex, full duplex)	
<b>Audio input</b>	Input for external balanced or unbalanced microphone Digital input, optional 12 V ring power Balanced or unbalanced line input Input through microphone pairing	
<b>Audio output</b>	Output through speaker pairing	
<b>Audio encoding</b>	AAC-LC 8/16/32/44.1/48 kHz, G.711 PCM 8 kHz, G.726 ADPCM 8 kHz, Opus 8/16/48 kHz, LPCM 48 kHz	
<b>Network</b>		
<b>Network protocols</b>	IPv4, IPv6 USGv6, ICMPv4/ICMPv6, HTTP, HTTPS <sup>b</sup> , HTTP/2, TLS <sup>c</sup> , QoS Layer 3 DiffServ, FTP, SFTP, CIFS/SMB, SMTP, mDNS (Bonjour), UPnP <sup>d</sup> , SNMP v1/v2c/v3 (MIB-II), DNS/DNSv6, DDNS, NTP, NTS, RTSP, RTP, SRTP/RTSPS, TCP, UDP, IGMPv1/v2/v3, RTCP, ICMP, DHCPv4/v6, ARP, SSH, LLDP, CDP, MQTT v3.1.1, Secure syslog (RFC 3164/5424, UDP/TCP/TLS), Link-Local address (ZeroConf)	
<b>System integration</b>		
<b>Application Programming Interface</b>	Open API for software integration, including VAPIX <sup>®</sup> , metadata and AXIS Camera Application Platform (ACAP); specifications at <a href="https://axis.com/developer-community">axis.com/developer-community</a> . One-click cloud connection ONVIF <sup>®</sup> Profile G, ONVIF <sup>®</sup> Profile M, ONVIF <sup>®</sup> Profile S, and ONVIF <sup>®</sup> Profile T, specifications at <a href="https://onvif.org">onvif.org</a>	
<b>Video management systems</b>	Compatible with AXIS Camera Station Edge, AXIS Camera Station Pro, AXIS Camera Station 5, and video management software from Axis' partners available at <a href="https://axis.com/vms">axis.com/vms</a> .	
<b>Onscreen controls</b>	Autofocus Day-night shift Defog Electronic image stabilization Enable-disable all privacy masks Fan Heater IR LED Play media clip Timed wiper Video streaming indicator WDR	
<b>Edge-to-edge</b>	Microphone pairing Speaker pairing	
<b>Event conditions</b>	Audio: audio detection Casing open Device status: above/below/within operating temperature, IP address blocked, IP address removed, live stream active, network lost, new IP address, system ready, ring power overcurrent protection, shock detected Digital audio: digital signal contains Axis metadata, digital signal has invalid sample rate, digital signal missing, digital signal okay Edge storage: recording ongoing, storage disruption, storage health issues detected Faulty front window I/O: digital input, manual trigger, virtual input MQTT: stateless Scheduled and recurring: schedule Video: average bitrate degradation, day-night mode	
<b>Event actions</b>	Day-night mode Defog Guard tour I/O LEDs MQTT Notification: HTTP, HTTPS, TCP and email Overlay text Recordings Security SNMP trap messages Images or video clips: FTP, SFTP, HTTP, HTTPS, network share and email WDR mode Wiper	

<b>Built-in installation aids</b>	Remote zoom and focus Pixel counter Traffic camera installation assistance
<b>Analytics</b>	
<b>Applications</b>	<b>Included</b> AXIS Object Analytics, AXIS Scene Metadata, AXIS Image Health Analytics, AXIS Live Privacy Shield <sup>d</sup> , AXIS Speed Monitor <sup>e</sup> <b>Supported</b> AXIS License Plate Verifier Support for AXIS Camera Application Platform enabling installation of third-party applications, see <a href="https://axis.com/acap">axis.com/acap</a>
<b>AXIS Object Analytics</b>	<b>Object classes:</b> humans, vehicles (types: cars, buses, trucks, bikes, other) <b>Scenarios:</b> line crossing, object in area, time in area, crossline counting, occupancy in area, motion in area, motion line crossing Up to 10 scenarios <b>Other features:</b> triggered objects visualized with trajectories, color-coded bounding boxes and tables Polygon include/exclude areas Perspective configuration ONVIF Motion Alarm event
<b>AXIS Image Health Analytics</b>	<b>Detection settings:</b> Tampering: blocked image, redirected image Image degradation: blurred image, underexposed image <b>Other features:</b> sensitivity, validation period
<b>AXIS Scene Metadata</b>	<b>Object classes:</b> humans, faces, vehicles (types: cars, buses, trucks, bikes), license plates <b>Object attributes:</b> vehicle color, upper/lower clothing color, confidence, position
<b>Approvals</b>	
<b>Product markings</b>	CSA, UL/cUL, CE, VCCI, RCM
<b>Supply chain</b>	TAA compliant
<b>EMC</b>	CISPR 35, CISPR 32 Class A, EN 55035, EN 55032 Class A, EN 50121-4, EN 61000-3-2, EN 61000-3-3, EN 61000-6-1, EN 61000-6-2, IEC 62236-4 <b>Australia/New Zealand:</b> RCM AS/NZS CISPR 32 Class A <b>Canada:</b> ICES(A)/NMB(A) <b>Japan:</b> VCCI Class A <b>USA:</b> FCC Part 15 Subpart B Class A
<b>Safety</b>	CAN/CSA C22.2 No. 62368-1 ed. 3, IEC/EN/UL 62368-1 ed. 3
<b>Environment</b>	IEC 60068-2-1, IEC 60068-2-2, IEC 60068-2-6, IEC 60068-2-14, IEC 60068-2-27
<b>Network</b>	NIST SP500-267
<b>Cybersecurity</b>	ETSI EN 303 645, BSI IT Security Label, FIPS 140
<b>Cybersecurity</b>	
<b>Edge security</b>	<b>Software:</b> Signed OS, brute force delay protection, digest authentication and OAuth 2.0 RFC6749 OpenID Authorization Code Flow for centralized ADFS account management, password protection <b>Hardware:</b> Axis Edge Vault cybersecurity platform Secure element (CC EAL 6+, FIPS 140-3 Level 3), system-on-chip security (TEE), Axis device ID, secure keystore, signed video, secure boot, encrypted filesystem (AES-XTS-Plain64 256bit)
<b>Network security</b>	IEEE 802.1X (EAP-TLS, PEAP-MSCHAPv2) <sup>f</sup> , IEEE 802.1AR, HTTPS/HSTS9, TLS v1.2/v1.3 <sup>h</sup> , Network Time Security (NTS), X.509 Certificate PKI, host-based firewall
<b>Documentation</b>	<i>AXIS OS Hardening Guide</i> <i>Axis Vulnerability Management Policy</i> <i>Axis Security Development Model</i> AXIS OS Software Bill of Material (SBOM) To download documents, go to <a href="https://axis.com/support/cybersecurity/resources">axis.com/support/cybersecurity/resources</a> To read more about Axis cybersecurity support, go to <a href="https://axis.com/cybersecurity">axis.com/cybersecurity</a>
<b>General</b>	
<b>Casing</b>	Aluminum and plastic casing Color: NCS S 9000-N
<b>Mounting</b>	¼"-20 UNC tripod screw thread Camera stand included
<b>Power</b>	Power over Ethernet IEEE 802.3af/802.3at Type 1 Class 3 Typical: 7.5 W, max 12.95 W

	10–28 V DC, typical 7.0 W, max 12.95 W
<b>Connectors</b>	Network: Shielded RJ45 10BASE-T/100BASE-TX/1000BASE-T PoE Network: IDC punchdown connector PoE I/O: 6-pin 2.5 mm terminal block for four configurable inputs Serial communication: RS485/RS422, 2 pcs, 2 pos, full duplex, terminal block Audio: 3.5 mm mic/line in Power: DC input, terminal block HDMI Type D AHI (Axis Housing Interface) Security lock slot
<b>Storage</b>	Support for microSD/microSDHC/microSDXC card Support for SD card encryption (AES-XTS-Plain64 256bit) Recording to network-attached storage (NAS) For SD card and NAS recommendations see <a href="https://axis.com">axis.com</a>
<b>Operating conditions</b>	Temperature: -10 °C to 60 °C (14 °F to 140 °F) Humidity: 10–85% RH (non-condensing)
<b>Storage conditions</b>	Temperature: -40 °C to 65 °C (-40 °F to 149 °F) Humidity: 5–95% RH (non-condensing)
<b>Dimensions</b>	For the overall product dimensions, see the dimension drawing in this datasheet.
<b>Weight</b>	13 mm lens: 529 g (1.2 lb) 48 mm lens: 611 g (1.3 lb)
<b>Box content</b>	Camera, installation guide, owner authentication key, stand, terminal block connectors, allen key
<b>Optional accessories</b>	AXIS TQ1809-LE Housing T92G AXIS TQ1904 Mounting Bracket AXIS T8415 Wireless Installation Tool AXIS Surveillance Cards For more accessories, go to <a href="https://axis.com/products/axis-q1728#compatible-products">axis.com/products/axis-q1728#compatible-products</a>
<b>System tools</b>	AXIS Site Designer, AXIS Device Manager, product selector, accessory selector, lens calculator Available at <a href="https://axis.com">axis.com</a>
<b>Languages</b>	English, German, French, Spanish, Italian, Russian, Simplified Chinese, Japanese, Korean, Portuguese, Polish, Traditional Chinese, Dutch, Czech, Swedish, Finnish, Turkish, Thai, Vietnamese
<b>Warranty</b>	5-year warranty, see <a href="https://axis.com/warranty">axis.com/warranty</a>
<b>Part numbers</b>	Available at <a href="https://axis.com/products/axis-q1728#part-numbers">axis.com/products/axis-q1728#part-numbers</a>
<b>Sustainability</b>	
<b>Substance control</b>	PVC free, BFR/CFR free in accordance with JEDEC/ECA Standard JS709 RoHS in accordance with EU RoHS Directive 2011/65/EU and 2015/863, and standard EN IEC 63000:2018 REACH in accordance with (EC) No 1907/2006. For SCIP UUID, see <a href="https://echa.europa.eu">echa.europa.eu</a>
<b>Materials</b>	<b>Renewable carbon-based plastic content</b> 13 mm lens: 37% (recycled) 48 mm lens: 42% (recycled) Screened for conflict minerals in accordance with OECD guidelines To read more about sustainability at Axis, go to <a href="https://axis.com/about-axis/sustainability">axis.com/about-axis/sustainability</a>
<b>Environmental responsibility</b>	<a href="https://axis.com/environmental-responsibility">axis.com/environmental-responsibility</a> Axis Communications is a signatory of the UN Global Compact, read more at <a href="https://unglobalcompact.org">unglobalcompact.org</a>

- We recommend a maximum of 3 unique video streams per camera or channel, for optimized user experience, network bandwidth, and storage utilization. A unique video stream can be served to many video clients in the network using multicast or unicast transport method via built-in stream reuse functionality.
- This product includes software developed by the OpenSSL Project for use in the OpenSSL Toolkit. ([opendss.org](https://opendss.org)), and cryptographic software written by Eric Young ([ey@cryptsoft.com](mailto:ey@cryptsoft.com)).
- This product includes software developed by the OpenSSL Project for use in the OpenSSL Toolkit. ([opendss.org](https://opendss.org)), and cryptographic software written by Eric Young ([ey@cryptsoft.com](mailto:ey@cryptsoft.com)).
- Available for download
- Available for download
- This product includes software developed by the OpenSSL Project for use in the OpenSSL Toolkit. ([opendss.org](https://opendss.org)), and cryptographic software written by Eric Young ([ey@cryptsoft.com](mailto:ey@cryptsoft.com)).
- This product includes software developed by the OpenSSL Project for use in the OpenSSL Toolkit. ([opendss.org](https://opendss.org)), and cryptographic software written by Eric Young ([ey@cryptsoft.com](mailto:ey@cryptsoft.com)).

h. *This product includes software developed by the OpenSSL Project for use in the OpenSSL Toolkit. (openssl.org), and cryptographic software written by Eric Young (eay@cryptsoft.com).*

## Detect, Observe, Recognize, Identify (DORI)

### 13 mm lens

	DORI definition	Distance (wide)	Distance (tele)
Detect	25 px/m (8 px/ft)	84.6 m (277.5 ft)	177.9 m (583.5 ft)
Observe	63 px/m (19 px/ft)	33.6 m 110.2 ft)	70.6 m (231.6 ft)
Recognize	125 px/m (38 px/ft)	16.9 m (55.4 ft)	35.6 m (116.8 ft)
Identify	250 px/m (76 px/ft)	8.5 m (27.9 ft)	17.8 m (58.4 ft)

### 48 mm lens

	DORI definition	Distance (wide)	Distance (tele)
Detect	25 px/m (8 px/ft)	211 m (692.1 ft)	672.9 m (2207.1 ft)
Observe	63 px/m (19 px/ft)	83.7 m (274.5 ft)	267.0m (875.8 ft)
Recognize	125 px/m (38 px/ft)	42.2 m (138.4 ft)	134.6 m (441.5 ft)
Identify	250 px/m (76 px/ft)	21.1 m (69.2 ft)	67.3 m (220.7 ft)

The DORI values are calculated using pixel densities for different use cases as recommended by the EN-62676-4 standard. The calculations use the center of the image as the reference point and consider lens distortion. The possibility to recognize or identify a person or object depends on factors such as object motion, video compression, lighting conditions, and camera focus. Use margins when planning. The pixel density varies across the image, and the calculated values can differ from the distances in the real world.

# Dimension drawing

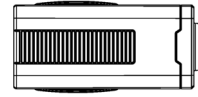
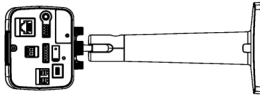
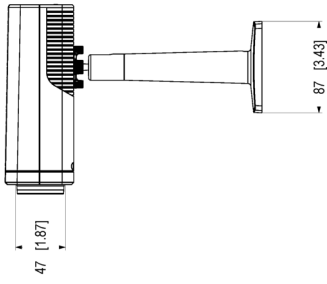
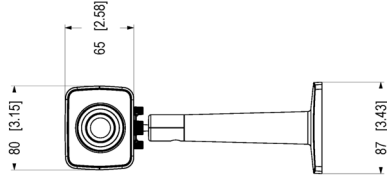
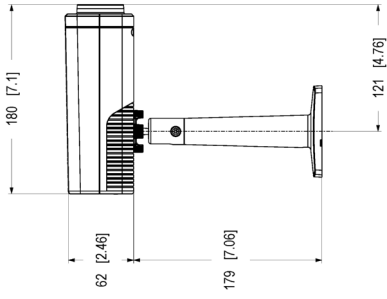
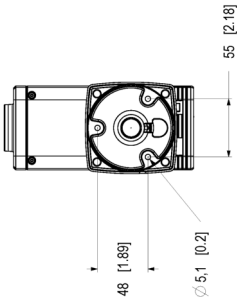
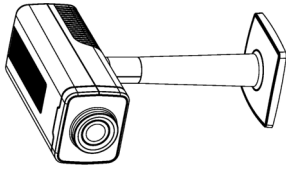

Dimension in mm [inch]	
2010-02-27	MPS 1.2
377828	A1 1.10

AXIS Q1728 Block Camera

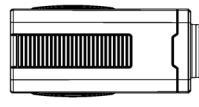
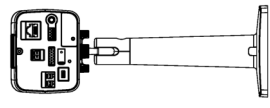
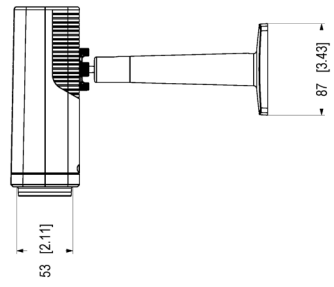
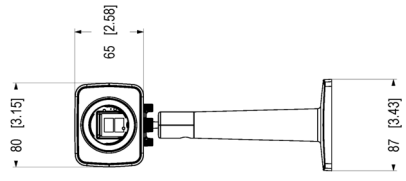
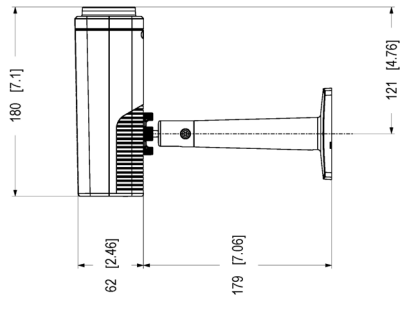
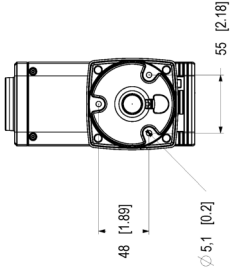
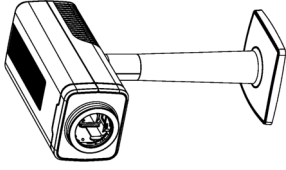

Dimensions in mm [inch]

20140302	Rev. 1.2
211007	AI - 110

AXIS Q1728 Block Camera 48mm

## Highlighted capabilities

### Axis Edge Vault

Axis Edge Vault is the hardware-based cybersecurity platform that safeguards the Axis device. It forms the foundation that all secure operations depend on and offer features to protect the device's identity, safeguard its integrity and protect sensitive information from unauthorized access. For instance, **secure boot** ensures that a device can boot only with **signed OS**, which prevents physical supply chain tampering. With signed OS, the device is also able to validate new device software before accepting to install it. And the **secure keystore** is the critical building-block for protecting cryptographic information used for secure communication (IEEE 802.1X, HTTPS, Axis device ID, access control keys etc.) against malicious extraction in the event of a security breach. The secure keystore and secure connections are provided through a Common Criteria or FIPS 140 certified hardware-based cryptographic computing module.

Furthermore, signed video ensures that video evidence can be verified as untampered. Each camera uses its unique video signing key, which is securely stored in the secure keystore, to add a signature into the video stream allowing video to be traced back to the Axis camera from where it originated.

To read more about Axis Edge Vault, go to [axis.com/solutions/edge-vault](https://www.axis.com/solutions/edge-vault).

### AXIS Object Analytics

AXIS Object Analytics is a preinstalled, multifeatured video analytics that detects and classifies humans, vehicles, and types of vehicles. Thanks to AI-based algorithms and behavioral conditions, it analyzes the scene and their spatial behavior within – all tailored to your specific needs. Scal-

able and edge-based, it requires minimum effort to set up and supports various scenarios running simultaneously.

### Electronic image stabilization

Electronic image stabilization (EIS) provides smooth video in situations where a camera is subject to vibrations. Built-in gyroscopic sensors continuously detect the camera's movements and vibrations, and they automatically adjust the frame to ensure you always capture the details you need. Electronic image stabilization relies on different algorithms for modeling camera motion, which are used to correct the images.

### Forensic WDR

Axis cameras with wide dynamic range (WDR) technology make the difference between seeing important forensic details clearly and seeing nothing but a blur in challenging light conditions. The difference between the darkest and the brightest spots can spell trouble for image usability and clarity. Forensic WDR effectively reduces visible noise and artifacts to deliver video tuned for maximal forensic usability.

### Lightfinder

The Axis Lightfinder technology delivers high-resolution, full-color video with a minimum of motion blur even in near darkness. Because it strips away noise, Lightfinder makes dark areas in a scene visible and captures details in very low light. Cameras with Lightfinder discern color in low light better than the human eye. In surveillance, color may be the critical factor to identify a person, an object, or a vehicle.