

AXIS TA4601 Surface Mount

Installation guide

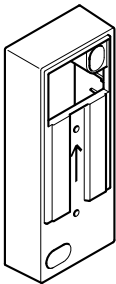

1x



2x



1:1



axis.com/products/axis-ta4601-surface-mount/support



Drill template

1.1

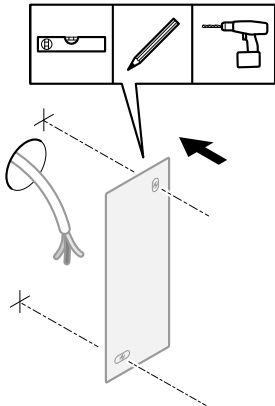

1.2

AXIS A4612 Network Bluetooth® Reader

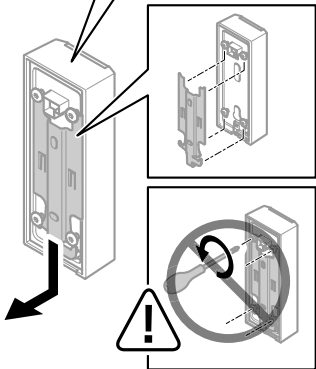

1.3

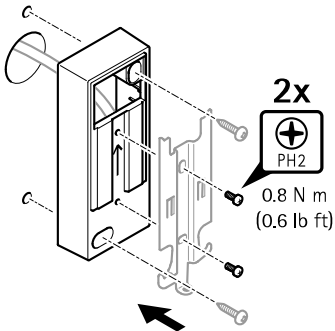

1.4

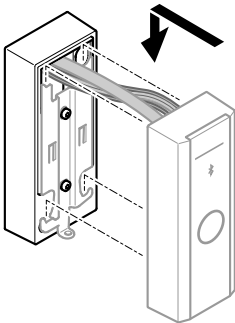

1.5

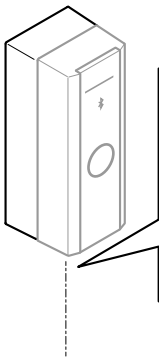

1x



0.8 N m
(0.6 lb ft)

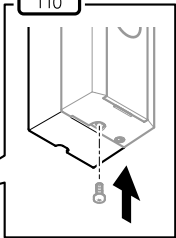

1.6

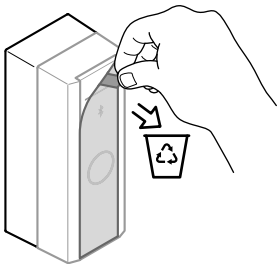

1.7



help.axis.com

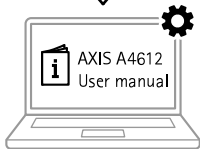

Installation guide

AXIS TA4601 Surface Mount

© 2024 Axis Communications AB

Ver. M1.5

Date: April 2024

Part no. 3032155